

**SL1600 Interior Layout**

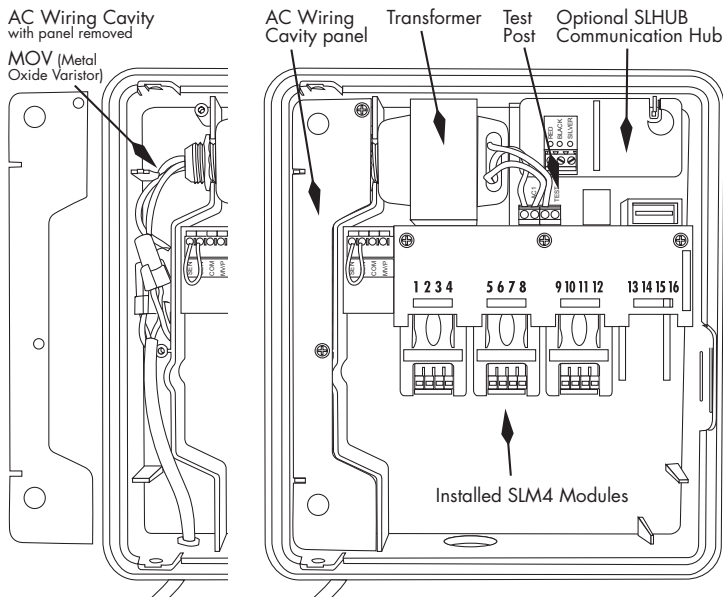

**1. Controller Installation**

All SL1600 controller housings are designed for indoor or outdoor installation. Your SL1600 controller can be located in any convenient spot such as inside the garage or on an outside wall. It is recommended that you choose a location where the irrigation system will not be spraying directly on the controller, in the event the housing door is left open.

- Open the controller's front door, then open the control panel of your SL1600 controller.
- Remove the control panel from the SL1600 controller housing by pushing upward and outward to remove from the hinges, then set the control panel aside in a safe place.
- Mount the SL1600 controller with or without the SL1600 controller Quick Mount bracket.

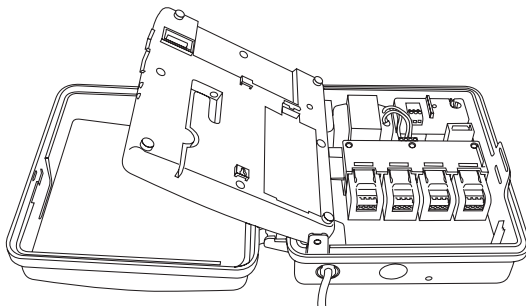

**2A. Installing With Quick Mount Bracket (recommended)**

- Determine mounting height for easy viewing and be sure to mount low enough for field wires to reach all controller wiring terminals and test post at top of controller.
- Place the mounting bracket against the wall so that the word "CONTROLLER SIDE" is visible and the open ends of the housing retainers are pointing upward.
- Using one of the mounting screws (or a pencil) mark the location onto the wall of the top/center hole (see photo).
- Install a wall anchor in the marked position then install the bracket onto the anchor using one of the mounting screws provided (do not tighten screw fully yet). The center screw will automatically level the bracket on the wall. After level is set, mark the other mounting holes and install the remaining wall anchors.
- Install other screws through bracket into anchors (except for bottom center screw) and tighten all screws.

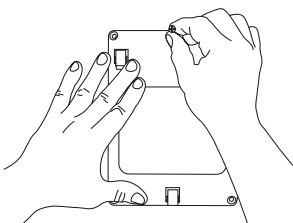

- Align the three retainers on back of the controller housing onto the mounting bracket and lower it into place.
- For additional security, install a bottom center mounting screw from the inside of the controller. Drive the provided screw through the mounting notch located just below the zone modules to secure the controller to the bracket.

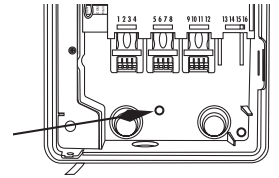

**2B. Installing Without Quick Mount Bracket**

- Determine mounting height for easy viewing and be sure to mount low enough for field wires to reach controller wiring terminals and test post at top of controller.
- Install a wall anchor in the desired location. This will be for the top/center hanger hole of the controller.
- Install one of the mounting screws provided into the wall anchor.

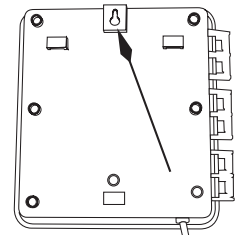

Hang the controller on the mounting screw by positioning the controller on the head of the mounting screw. Check the controller for level, then drive a 2<sup>nd</sup> screw into the "notch" inside the bottom/center location to mark position for second anchor. Remove controller from top keyhole and install second anchor and then remount controller and tighten both screws to secure unit.

**3. SLM4 Module Installation**

- The SL1600 controller is equipped with one 4-zone module (SLM4). Additional SLM4 modules may be added to expand capacity to 16 zones. The SL1620 has 20 fixed zones; the SL1624 has 24 fixed zones. The SLM4 module is useable only on the SL1600.
- The SL1600 controller will automatically recognize the additional zones as they are installed. No special programming or resetting is required to initialize the modules.
- You can insert or remove a module without removing power from the controller.
- To install a module, push the module into the channels until you feel it lock in place. To remove a module, push DOWN on the center release panel on the top of the module and use the top tab to pull it out.

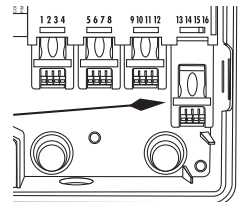

**!** Note: Modules must be inserted in the sequence of numbered zones. Do not leave any gaps in module positions.

**4. AC Power Wiring**

- Plug the included 6-foot line cord into a 120VAC outlet. **(E-SL1600 units for international use are prewired for 230VAC.)**
- Do NOT use a switch controlled wall outlet for operating an irrigation controller.



**Alternate Wiring**

If you are mounting your SL1600 controller outdoors or local electrical codes require hard wiring, proceed with the following steps.

**Warning: Connecting the SL1600 controller to the primary power should be done by a licensed electrician following all local codes. To prevent electrical shock, make sure all supply power is turned OFF at the breaker before connecting these wires. Electrical shock can cause severe injury or death. This controller is not intended for use by children. Do not allow children to play with the controller.**

- Remove the screws that secure the AC Wiring Cavity Panel. This will allow access to the transformer wiring.
- Remove the existing wire nuts connected to the transformer wires.
- For use with conduit, simply remove the line cord knockout. To do this, use a small, flat screwdriver blade in the slot of the knockout on the underside of the controller housing. Tap out the knockout with a hammer. Install the conduit and wiring. Discard the line cord.
- For **120VAC** operation, using wire nuts, make the wire connections indicated in the chart below.
- For **230VAC** operation, using wire nuts, make the wire connections indicated in the chart below.
- Replace the AC Wire Cavity Panel and secure with the screws.
- Return to the breaker box and turn on the circuit breaker. Verify that the controller no longer displays "no AC." This indicates that the AC power is on.

Wire connections for 120VAC	TRANSFORMER WIRE COLOR	AC INPUT WIRE	NOTE
	WHITE	NEUTRAL	
	BLACK	120VAC HOT	
	RED	<b>DO NOT USE</b> -230VAC (cover with wire nut)	
	GREEN/ YELLOW	EARTH GROUND	(typically green wire)

  

Wire connections for 230VAC	TRANSFORMER WIRE COLOR	AC INPUT WIRE	NOTE
	WHITE	NEUTRAL	
	BLACK	<b>DO NOT USE</b> -120VAC (cover with wire nut)	
	RED	230VAC HOT	
	GREEN/ YELLOW	EARTH GROUND	

**5. 24VAC Valve Wiring**

**WARNING: Never mix 24VAC and high voltage wiring in the same conduit.**

- For **solid wires**, simply push to insert the stripped end of valve wire into the module connector.
- For **stranded wires**, use a small screwdriver blade to push back the orange slide lock trigger first, then insert the stranded wire while holding the trigger in the open position. When you release the orange slide trigger, the wire will lock in place.
- **Knockouts:** The SL1600 controller provides several convenient knockouts for your choice of routing for valve and accessory 24VAC wiring. The knockouts should be removed by striking with a hammer and screwdriver inwards, toward the inside of the housing.

 Note: Your SL1600 controller utilizes screwless terminals for fast installation.

 Note: To **remove wires**, push back the orange slide trigger using a small screwdriver and then pull out the wire to remove.

- **COM (Valve Common):** Connect the Valve Common wire to the **COM** terminal.
- **MV/P (Master Valve/Pump Terminal):** Connect one wire to the **COM** position and the second wire to the **MV/P** position. Polarity is not important. Note that the total current of the activated Pump Start Relay AND valve(s) cannot exceed the maximum output current (default is 1.3A).

- **SEN (Rain/Freeze/Wind Sensor):** If you are using an optional rain, freeze, or wind sensor, use the **SEN** terminals for these devices. There is no polarity required for these wires. Remove and discard the factory installed wire jumper.
- **Zone Wires:** Connect a zone wire to a terminal on the SLM4 Module. Your SL1600 controller can power a total of 3 valves concurrently or a total of 2 valves with one master valve. Take caution when running a pump start relay so maximum output current does not exceed 1.3A. To locate a zone, touch zone wire to the **TEST POST** and determine which zone valve is ON. Note that the TEST POST is **HOT** even when the control panel is not in the housing.

 *Note: If you are NOT using an optional rain or freeze sensor, the wire jumper must be in place for your valves to turn ON. The jumper must also be in place if you are using the SLW weather station. SLW WEATHER STATION DOES NOT ATTACH TO THESE TERMINALS.*

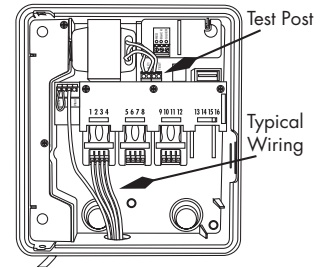

**9V Battery Installation (optional)**

SL1600 controllers with firmware versions later than 1.10 do not require a battery for clock time retention. A 9-volt battery may be installed for operating the display when the panel is open or for programming while the panel is outside the housing.

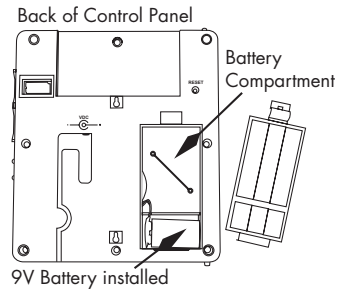

**6. Control Panel Installation**

- With the controller and optional SLW On-Site Weather Station installation complete, re-insert the control panel into the housing. To do this, hold the operating panel at a 90 degree angle from the housing (see photo at right) and position the top of the panel slightly toward the housing and slip the top post into the top hinge, then push the bottom post into the lower hinge. The panel should now swing open and close freely on the hinges.

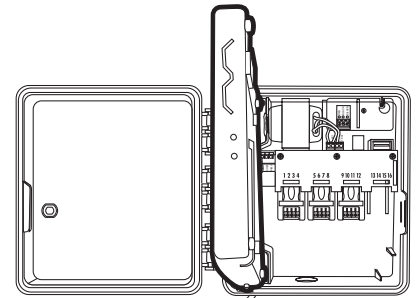

- The SL1600 controller will automatically restore power and communication to the control panel as soon as it is firmly closed. No ribbon cable is required.

Installation is complete! Proceed to your Owner's Manual to program your SL1600 controller.

